

LH DRAWN
 R.H OPPOSITE

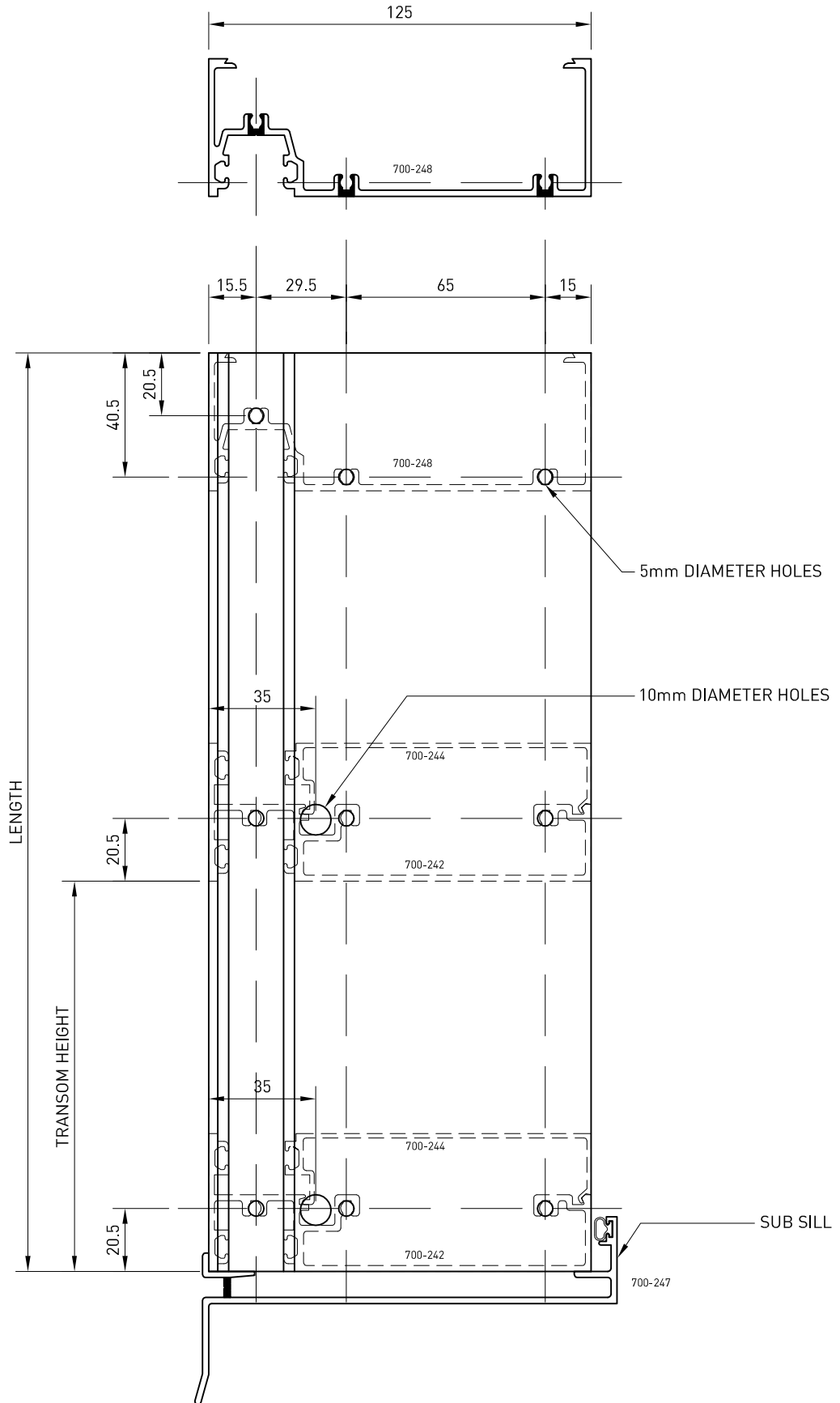

Up to date stock availability can be viewed at www.lidco.com.au/indices

COMMERCIAL RANGE 718 SYSTEM

Emporia™ 125mm Face Glazed

LH DRAWN
R.H OPPOSITE

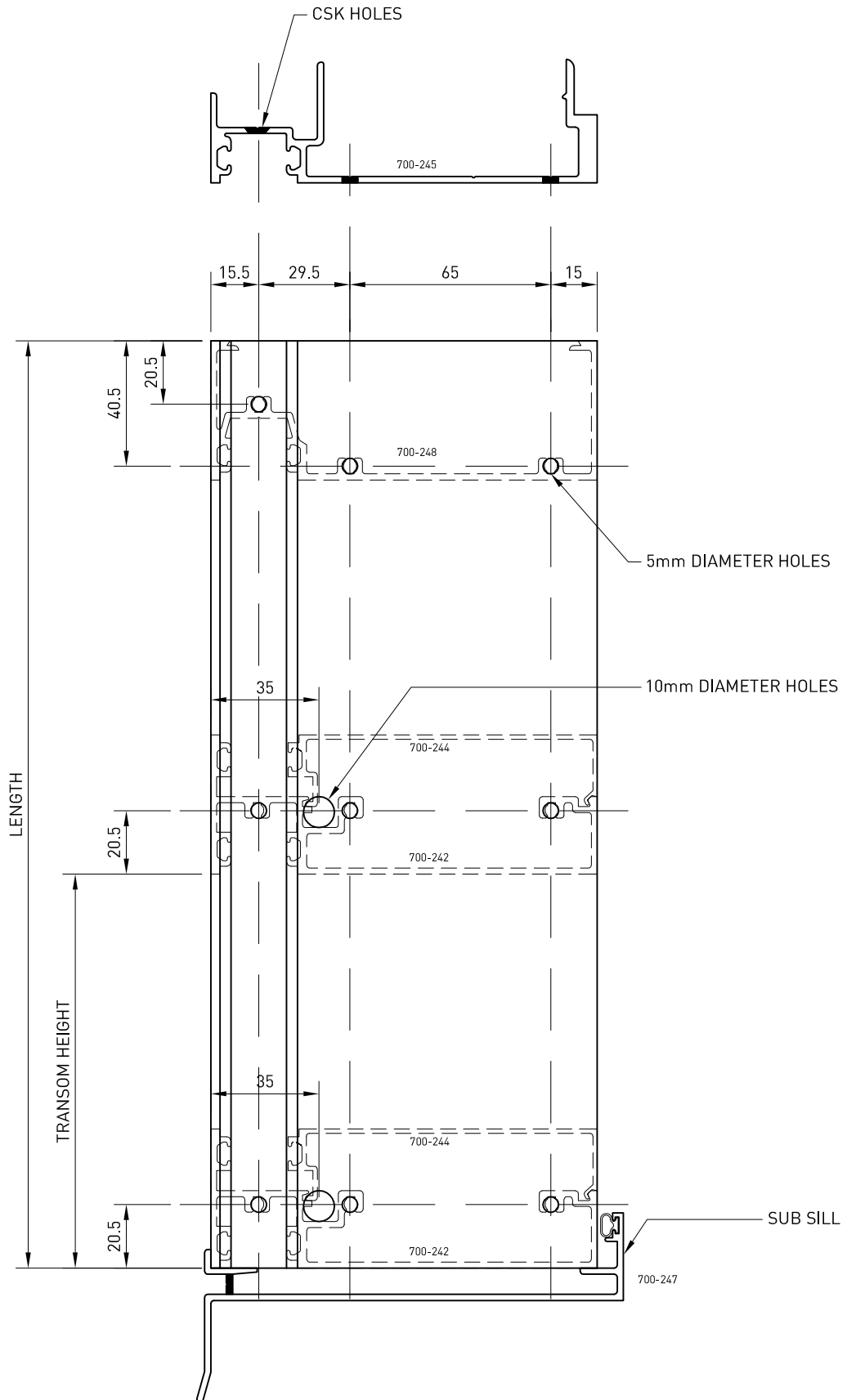

Up to date stock availability can be viewed at www.lidco.com.au/indices

LH DRAWN
R.H OPPOSITE

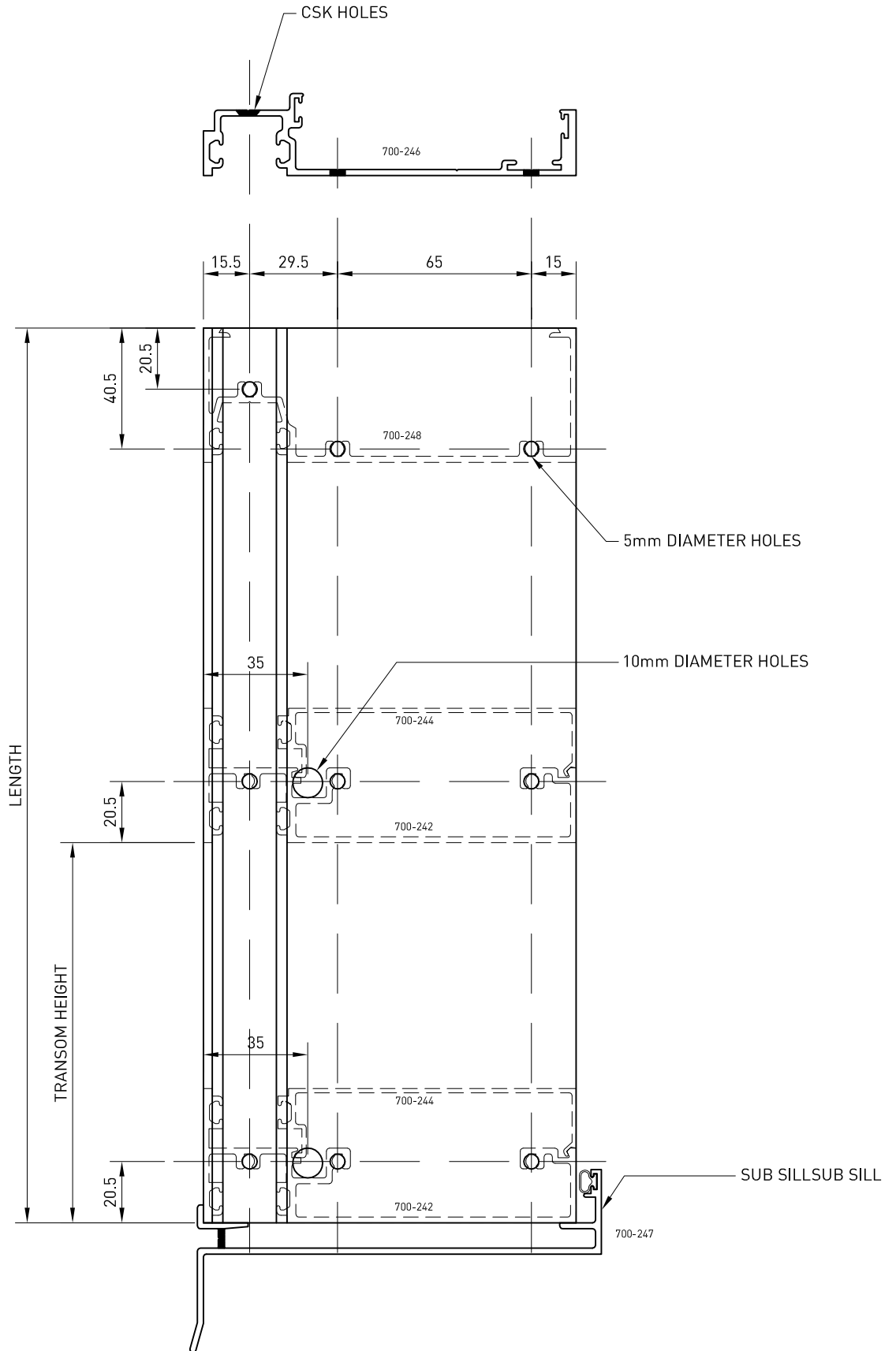

Up to date stock availability can be viewed at www.lidco.com.au/indices

COMMERCIAL RANGE 718 SYSTEM

Emporia™ 125mm Face Glazed

SILL &
SUB SILL MACHINING

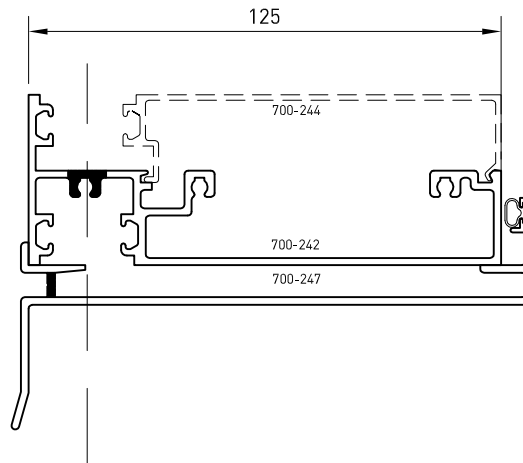

ADDITIONAL SLOTS REQUIRED IF
THE LENGTH EXCEEDS 1200mm
(500mm MAX CENTRES SPACING)

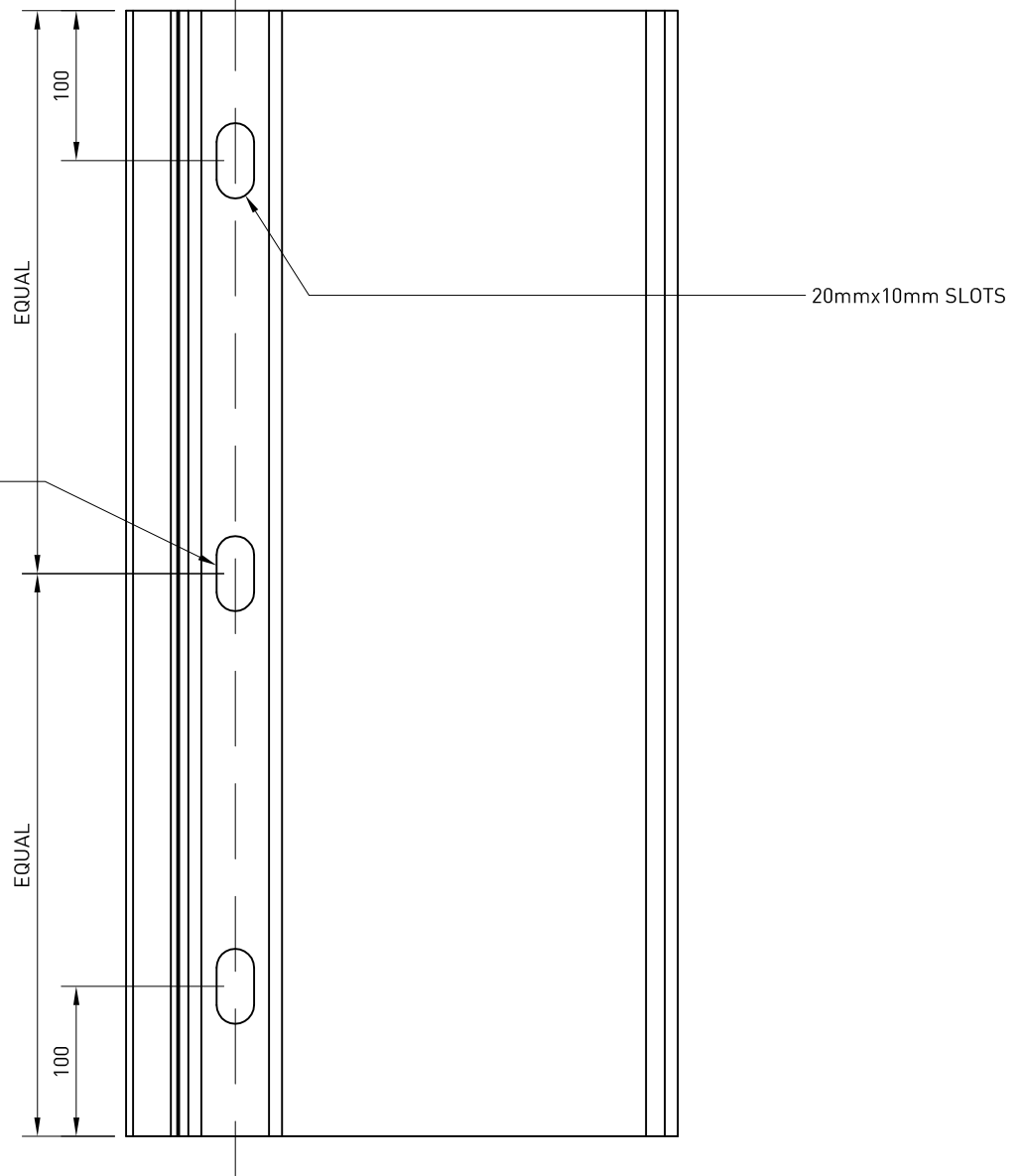

Up to date stock availability can be viewed at www.lidco.com.au/indices

NOTE:
 MACHINING IS REQUIRED
 WHEN DYNABOLT IS
 USED AT SUB SILL

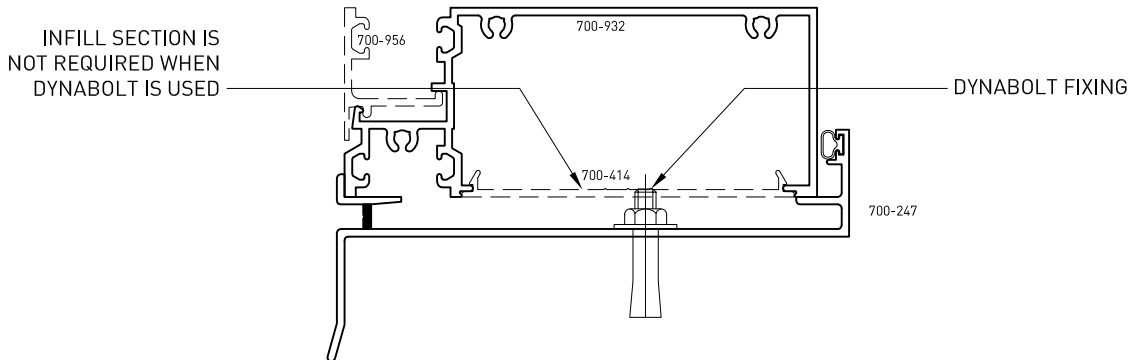
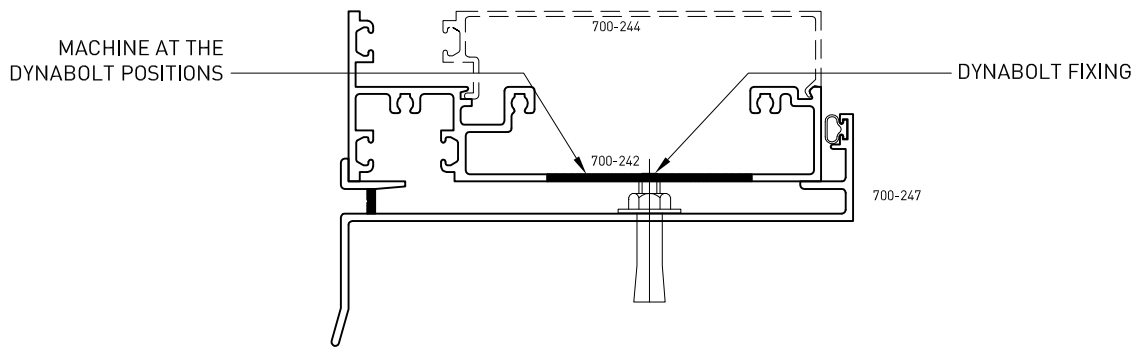

Up to date stock availability can be viewed at www.lidco.com.au/indices